

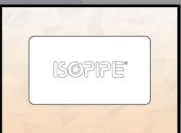

ISOPIPE[®]

Integrated Insulation Systems

Installation Guide

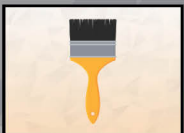

ISOPIPE®

Integrated Insulation Systems

Rebuild the future!

www.isopipe.eu

	Page
1. GENERAL INFORMATION	
1.1 History	2
1.2 Certifications	4
1.3 ISOPIPE Insulation Calculator	5
2. PRODUCTS INFORMATION	
2.1 Applications	6
2.2 Product Range	7
2.3 ISOPIPE Insulation	8-9
ISOPIPE TC	8
ISOPIPE HT-HF	9
2.4 ISOPIPE Coverings	10-11
SOLAR COVERING	10
HP COVERING	10
UV PLUS COVERING	11
HEAVY DUTY COVERING	11
2.5 Accessories	12-15
ISOTAPE	12
ISOGLUE	14
ISOCAMPS	15
ISOCOVER	15
3. INSTALLATION GUIDE	
3.1 Important Information	16-18
3.1.1 Terminology	16
3.1.2 Tool Kit	16
3.1.3 Important Notes Before Applying Insulation	17
3.1.4 ISOPIPE COVERINGS General instructions	17
3.1.5 ISOGLUE General instructions	18
3.1.6 Applying ISOTAPE & ISOCOVER	18

	Page
3.2 Pipes	19-20
3.2.1 Insulation on New Pipes	19
3.2.2 Bends	19
3.2.3 Installation on Existing Pipes	20
3.2.4 Installation on TWIN Pipes	21
3.2.5 Installation on INOX Fittings	21
3.3 Fittings, Connectors	22-30
3.3.1 General Information	22
3.3.2 T-Joints	22
3.3.4 Bends	23
3.3.5 Curves	25
3.3.6 Joints	26
3.3.7 Valves	27
3.3.8 Multilayer Insulation Pipes	28
3.3.9 Installation On Concentric Reducers	28
3.3.10 Installation on Couplings	29
3.3.11 Insulation On Pipe Supports	29
3.3.12 Installation on Strainers, Strainer Valves, Inclined Seat Valves	30
3.4 Sheets	31-33
3.4.1 On Large Pipes (over 114 mm)	31
3.4.2 On Flat Surfaces on Pipes (over 600mm using ISOGLUE)	32
3.4.3 On Flat Surfaces Using Self-Adhesive ISOROLLS, ISOSHEETS	32
3.4.4 For Tanks with Dome Top	33



1.1 History



1997: The Beginning

- **ISOPIPE S.A.** is engaged in the production of the widely used closed cell synthetic rubber insulation under the trademark **ISOPIPE**. Our extensive product range includes **ISOPIPE TC**, **ISOROLLS**, **ISOSHEETS** and **ISOSYSTEM**.
- **ISOPIPE S.A.** plant is located in Ritsona area of Halkida - north of Athens, with a production area of 20,000 m² and 4,000 m² of buildings.



2000: Award Ceremony

- ISOPIPE insulation by **ISOPIPE S.A.**, received a quality excellence award by the EUROPEAN Business Organization.



2002: Factory Expansion

- **ISOPIPE S.A.** expanded its production facilities to a total covered area of 40,000 m² and buildings of 8,000 m².



2006: Factory Expansion

- **ISOPIPE S.A.** further expanded its premises to a total covered area of 40,000 m² and buildings of 12,000 m².



2008: Boiler Production

- **ISOPIPE S.A.** produces cast iron boilers for central heating, under the name **TORRENT**. The boilers are produced in accordance with European Standards. The range includes boilers from 21,686 to 1,203,783 kcal/h or 25 to 1,400kw.
- **ISOSOL Pre - Insulated Pipes**
The high quality and wide range of our bare pipe (INOX, Copper, PE and PERT-AL-PERT) in combination with **ISOPIPE S.A.**'s expertise in closed-cell synthetic rubber elastomeric foam, offer an ergonomic and highly functional product.



2009: Barcelona Spain Subsidiary

- **ISOPIPE S.A.** created a subsidiary in Barcelona, Spain, under the name **ISOPIPE Ibérica sl.**
- **ISOPIPE HT-HF** is an environmentally friendly halogen free product, for higher temperature applications (+175°C).
- **UV PLUS COVERING:** is an aluminum external protection covering composed of three layers of polyester, aluminum and polyethylene, thus providing resistance both to ultra violet radiation and other atmospheric agents.
- **HEAVY DUTY (HD) COVERING:** is a superior reinforced external aluminum protection covering, offering high resistance against mechanical damage, ultra violet radiation, leakages and pipe corrosion. The **HEAVY DUTY COVERING** consists of three layers of Polyester, Aluminum and Fire Resistant (FR) PVC.



2007: Patented Product

- **ISOPIPE S.A.** introduced two new products, **ISOPIPE Slit & Seal** and **SOLAR Covering**.
- **ISOPIPE Slit & Seal:** Pre-slit pipe with self-adhesive tape and self-adhesive overlap.
- **SOLAR COVERING:** An absolute effective and reliable product for solar heating system, which combines the high-tech ISOPIPE insulation with our expertise in UV Covering, patented product.

1.1 History



2010: Factory Expansion

- **ISOPIPE S.A.** further expanded its facilities to a total covered area of 60,000 m² and buildings of 30,000 m².



2011: Sound Absorption

- **ISOSOUND** is a new sound absorption and sound insulation product of high performance, specially designed for specific applications.



2015: TWIN SOLAR COVERING

- The patented product by **ISOPIPE S.A.** is now available in **TWIN**, which offers quick, easy and trouble free installation! The connection of the tubes is made through a special protective film, which allow easy separation at any desired length. Also available in **ISOSOL TWIN** with or without cable.



2016 - 2017: New Innovations

- **ISOPIPE S.A.** invests in high technology machinery, research and development and testing laboratories to improve the quality of its products and to introduce new products in the market.
- Our production process is now under EN ISO 9001:2015.



2017: TORRENT Condensing

- **ISOPIPE S.A.** introduced **TORRENT New Cast Iron Condensing Boilers**, Class A worldwide.
- **ISOPIPE Insulation Calculator**, a new user-friendly app is launched for Tablet & Mobile Devices.



2018: Madrid Spain Subsidiary

- **ISOPIPE ibérica sl** created a subsidiary in Madrid, Spain.



2019: London UK Subsidiary

- **ISOPIPE S.A.** created **ISOPIPE UK Ltd**, a subsidiary in London, UK.
- **ISOPIPE S.A.** launched **HP COVERING** which is a special aluminum covering for hygienic and internal applications.



2020: New Products

ISOPIPE S.A. launched two new products:

- **ISODUCT:** Flexible elastomeric foam insulation with significantly high percentage of closed cells in the form of rolls, NBR based, width 1.5 m with or without self-adhesive. Also available with hygienic protection covering.
- **ISOCOIL 15m:** All the benefits of **ISOPIPE TC Pipes**, it is now delivered in a continuous length of 15 meters.

1.2 Certifications



ISOPIPE S.A. is committed to supply the market with high quality products, always complying with the latest standards.

All declared attributes of our products are acknowledged by well known notified bodies. Moreover, all test reports are repeated periodically to ensure constant performance.

All our products possess a **CE** mark as a declaration that they comply with the requirements of the relevant European Health, Safety and Environmental Protection legislation.

All company procedures are explicitly described in the **Quality Management System of ISOPIPE S.A.**, which is certified according to **ISO 9001**. Several additional certifications, even some required for specific markets are available upon request. A book with the most commonly asked certificates of our products can also be provided to our partners.



1.3 ISOPIPE Insulation Calculator

New User Friendly App for Tablet & Mobile Devices

ISOPIPE® Insulation Calculator

ISOPIPE Insulation Calculator has been developed to offer exact measurements for Certified Insulation, **ISOPIPE TC** (NBR) and **ISOPIPE HT-HF** (EPDM). Through the Program's Calculations you receive many recommendations, but also the techno-economic choice towards energy savings.

ISOPIPE Insulation Calculator Highlights:

- ✓ The app **works Offline**, online use while sending the PDF file
- ✓ **Save** the **Calculation** inside the Program
- ✓ More than **2000** Calculations can be Saved and seen any time
- ✓ **Send** the Calculation in any **Email** address in PDF form
- ✓ **Send** Multiple Saved Calculations in a **Single PDF** file
- ✓ **Translated** in **8 languages**
- ✓ **Download** it for **free** in **Apple Store** & **Google Play Store**

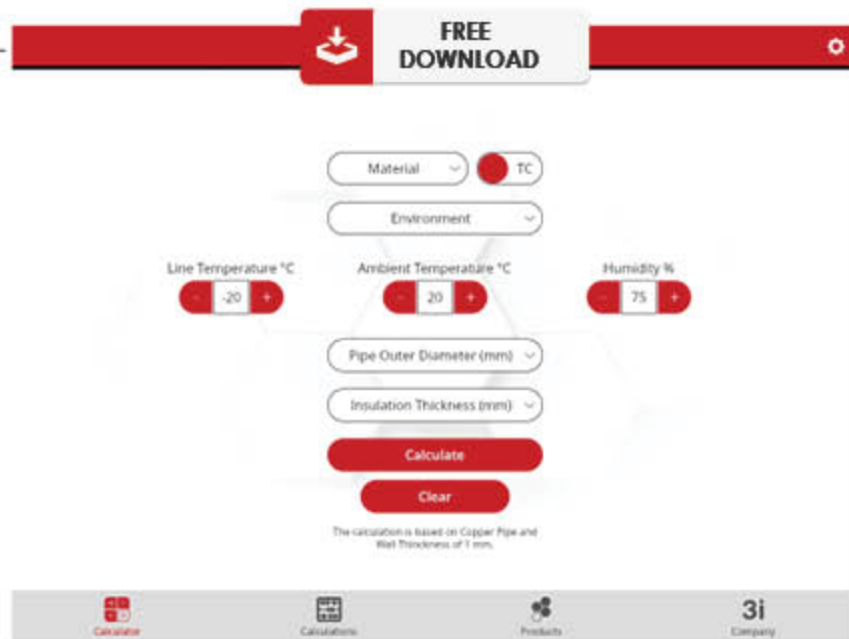

For Online application use, please visit:
<http://calculator.isopipe.eu>



2.1 Applications

ISOPIPE's unique applications.

Applications	Products											
	ISO PIPE TC	ISO PIPE TR	ISO PIPE HT-HF	SOLAR COVERING	UV PLUS COVERING	HP COVERING	HEAVY DUTY COVERING	SLIT & SEAL	ISO SOL TC	ISO SOL TC SOLAR	ISO SOUND	
 Antibacterial	✓	✓		✓ ¹	✓ ¹	✓ ¹	✓ ¹	✓	✓	✓		
 Chemical and Pharmaceutical			✓	✓ ²	✓ ²		✓ ²					
 Cold Water	✓	✓	✓	✓	✓	✓ ¹	✓	✓	✓	✓	✓	
 Enclosed Spaces	✓	✓	✓									
 Renovation - Already Existing Applications								✓				
 Food Industry			✓	✓	✓	✓ ¹	✓					
 Heating & Plumbing	✓	✓	✓	✓	✓	✓ ¹	✓	✓	✓	✓		
 HVAC	✓	✓		✓ ¹	✓ ¹	✓ ¹	✓ ¹	✓	✓	✓		
 Low Temperature Cryogenic	✓	✓		✓ ¹	✓ ¹	✓ ¹	✓ ¹	✓	✓	✓		
 Refrigeration	✓	✓		✓ ¹	✓ ¹	✓ ¹	✓ ¹	✓	✓	✓		
 Schools & Hospitals			✓	✓ ²	✓ ²		✓ ²					
 Ships & Trains	✓	✓		✓ ¹	✓ ¹		✓ ¹	✓				
 Solar Hot Water			✓	✓ ²	✓ ²		✓ ²					
 Sound Absorption											✓	
 Stadiums	✓	✓		✓ ¹	✓ ¹	✓ ¹	✓ ¹	✓				

¹with ISOPIPE TC Insulation

²with ISOPIPE HT-HF Insulation

2.2 Product Range



Pipes



Coil



Slit & Seal



System



Sheets



Rolls

						
 TC	✓	✓	✓	✓	✓	✓
 TR	✓		✓	✓	✓	✓
 HT-HF	✓		✓	✓	✓	✓
SOLAR	✓		✓	✓	✓	✓
SOLAR SG	✓					
HP	✓		✓	✓	✓	✓
UV PLUS	✓		✓	✓	✓	✓
HEAVY DUTY	✓				✓	✓

2.3 ISOPIPE Insulation

ISOPIPE[®] TC Long-term and reliable thermal efficiency

ISOPIPE TC is a NBR based flexible elastomeric foam insulation with significantly high percentage, **98.5%**, of **closed - cells**.

ISOPIPE TC ensures long-term and reliable thermal efficiency.



Properties	Technical Data
Thermal Conductivity (λ)	-20°C - 0.031 W/mk
	0°C - 0.033 W/mk
	20°C - 0.035 W/mk
	30°C - 0.036 W/mk
Permeability (μ)	≥ 7000
Operating Temperatures (°C)	-50°C to +110°C (+85°C if System, Sheets, Rolls are glued to the object with its whole surface)
Fire Rating (FR)	Coil, Pipes, Slit & Seal: B-S2, d0 Class 0, Class 1 Class A or Class 1 B ₁ -S2, d0 Low Flame Spread
	System, Sheets, Rolls: B-S3, d0
Density (ρ)	60 Kgr/m ³ , ± 10 Kgr/m ³
Closed Cells	98.5%
Fungi & Bacterial Resistance	Passed
Noise Reduction	Up to 30dB
CFC, HFC, HCFC	Free
Odor	Neutral

The mentioned values are these which have been measured in our laboratory, under typical conditions. They can be modified without prior notice. You are kindly requested to assert their validity before any special use.



Product Range



A wide range of Applications



ISOPIPE TC insulation systems safeguard improved air quality and environmental sustainability.

2.3 ISOPIPE Insulation

ISOPIPE[®] HT-HF

Ecological Halogen-free Solution for Higher Temperatures

ISOPIPE HT-HF is an EPDM based, halogen free, closed cell synthetic rubber elastomeric foam for temperatures up to +175°C.

Properties	Technical Data
Thermal Conductivity (λ)	0°C - 0.040 W/mk 40°C - 0.045 W/mk
Permeability (μ)	≥ 4000
Operating Temperatures (°C)	-50°C to +150°C (+175°C) (+85°C if System, Sheets, Rolls are glued to the object with its whole surface)
Fire Rating (FR)	Euroclass E
Density (ρ)	60 - 75 Kgr/m ³
Noise Reduction	Up to 30dB
Halogen	Free
PVC-ODP zero	Free
CFC, HFC, HCFC	Free
Odor	Neutral

The mentioned values are these which have been measured in our laboratory, under typical conditions. They can be modified without prior notice. You are kindly requested to assert their validity before any special use.



Ethylene
Propylene
Diene
Monomer
EPDM

EN 13501
Class E

-50°C

+175°C

μ
 $\geq 4,000$

Product Range



ISOPIPE HT-HF is without:



A wide range of Applications



2.3 ISOPIPE Coverings

SOLAR COVERING

External Protection Covering against Harsh Weather & UV Radiation

SOLAR COVERING is a special polymer external protection membrane, offering resistance to ultra violet radiation and other atmospheric agents.

Available in White, Silver & Black Colour.

Available in Insulation of: ISOPIPE TC (+110°C) or ISOPIPE HT-HF (+175°C).

Permeability: Increased resistance to water vapour transmission.

SOLAR Protection: Its external surface may not exhibit aesthetic defects for at least several years after prolonged exposure to UV radiation.

Flexibility: Continuous long term performance.

Temp. Range on Surface of Covering: -40°C to +80°C

Lifespan (est.): +5 years

Warranty: 3 years



Also available in:

- SOLAR SG: a corrugated special polymer external protection membrane, available in Insulation of: ISOPIPE TC (+110°C)
- SOLAR TWIN: two connected tubes through a special protective film, allowing easy separation at any desired length

HP COVERING

Hygienic Protection Covering, Ideal for Internal Use

Hygienic Protection (HP) is an aluminum special covering for hygienic and internal applications, composed of five layers. HP Covering is mainly used for duct wrap in HVAC systems and other fields, having excellent water vapour diffusion resistance and flame-retardant properties.

Available in Insulation of: ISOPIPE TC (+110°C)

Thickness: 60 µm

Weight: 154 g/m²

Permeability: Increased water vapour diffusion resistance (µ) by more than 100%.

Flexibility: Continuous long term performance.

Temp. Range on Surface of Covering: -35°C to +120°C

Lifespan (est.): +6 years

Warranty: 5 years



2.3 ISOPIPE Coverings

UV PLUS COVERING

Aluminum Protection Covering with High Reflective Properties

UV PLUS COVERING is an aluminum external protection covering composed of three layers of polyester, aluminum and polyethylene, which provides resistance both to ultra violet radiation and other atmospheric agents.

Available in Insulation of: ISOPIPE TC (+110°C) or ISOPIPE HT-HF (+175°C).

Thickness: 99 µm

Weight: 125 g/m²

Permeability: Increased water vapour diffusion resistance (µ) by more than 100%.

Flexibility: Continuous long term performance.

Temp. Range on Surface of Covering: -40°C to +100°C

Lifespan (est.): +10 years

Warranty: 5 years



4 Layer Coverings



Exterior Use

HEAVY DUTY COVERING

Superior Aluminum Protection Covering with High Fire Resistance

HEAVY DUTY (HD) COVERING is a superior reinforced external aluminum protection covering, offering high resistance against mechanical damage, ultra violet radiation, leakages and pipe corrosion. The **HEAVY DUTY COVERING** consists of three layers of Polyester, Aluminum and Fire Resistant (FR) PVC.

Available in Insulation of: ISOPIPE TC (+110°C) or ISOPIPE HT-HF (+175°C).

Thickness: 230 µm

Weight: 340 g/m²

Permeability: Increased water vapour diffusion resistance (µ) by more than 10 times.

Flexibility: Continuous long term performance.

Temp. Range on Surface of Covering: -25°C to +75°C

Lifespan (est.): +15 years

Warranty: 7 years

Cover Puncture: Very high puncture and wear resistance. Fire will not spread through.

Ø 0.8 mm = 23 N

Ø 2.0 mm = 87 N



4 Layer Coverings



Exterior Use

ISOTAPE[®] 2.3 Accessories

Self-adhesive Insulation Tape

Closed cell structure with antimicrobial product protection

Pressure sensitive rubber insulation tape ideal for pipes, fittings and other tight areas where pipe insulation cannot be applied. Appropriate for cold and hot water applications.

Self adhesive reinforced with mesh scrim for extra support.



Available in Black colour



Interior Use

Description	Length	Width	Packaging
	m	mm	Unit/ Ctr
TC Insulation S/A tape	10 m	50 mm	10
TC Insulation S/A tape	15 m	50 mm	10
TC Insulation S/A tape	30 m	50 mm	10

Units per carton can be amended without notification.

SOLAR Polymer

Specially designed self adhesive tape for excellent weather and UV protection

Specially designed self adhesive tape, to be combined with SOLAR COVERING. Provides excellent weather and UV protection as well as permeability resistance.



Available in Silver, Black and White colour



Exterior Use

Description	Length	Width	Packaging
	m	mm	Unit/ Ctr
SOLAR Polymer	10 m	50 mm	24
SOLAR Polymer	25 m	50 mm	24

Units per carton can be amended without notification.

PVC

Strong and durable tape, based on premium grade PVC film

Based on a premium grade Plasticized Polyvinyl Chloride (PVC) film, coated with a non-thermosetting rubber-resin adhesive with good aging characteristics. Designed to be highly conformable and pursuant by moisture and other chemicals.



Exterior Use

Description	Length	Width	Packaging
	m	mm	Unit/ Ctr
White PVC	33 m	50 mm	40
Black PVC	33 m	50 mm	40

Units per carton can be amended without notification.



Available in Black and White colour

UV PLUS Pet-Al-Pe

Very strong & durable tape with excellent mechanical properties, in aluminum colour

Aluminum tape with high resistance to UV rays and atmospheric agents, specially designed for combination with UV Plus Covering.



Exterior Use

Description	Length	Width	Packaging
	m	mm	Unit/ Ctr
UV PLUS Pet-Al-Pe	10 m	50 mm	24
UV PLUS Pet-Al-Pe	25 m	50 mm	24

Units per carton can be amended without notification.



Available in Aluminum colour

2.3 Accessories

ISOGLUE® 255

High Quality glue for rubber insulation

ISOGLUE 255 is a solvent based contact adhesive designed specially for uniform and safe seam bonding of flexible insulation materials like elastomeric pipes and sheets applied on high temperature lines. Suitable for application on pipes and tanks with service temperatures up to 120°C.



Fully compatible glue for joining ISOPIPE TC, ISOPIPE TR and ISOPIPE HT-HF insulation.

Description	Packaging
	Unit/ Ctr
ISOGLUE 250 ml with brush	20
ISOGLUE 500 ml	12
ISOGLUE 1000 ml	12
ISOGLUE 1 gallon	5

Units per carton can be amended without notification.

ISOGLUE® HT 150

High Quality glue for rubber insulation



ISOGLUE HT 150 is a solvent based (Toluene Free) contact adhesive designed specially for uniform and safe seam bonding of flexible insulation materials like elastomeric pipes and sheets applied on high temperature lines. Suitable for application on pipes and tanks with service temperatures up to 150°C.



Fully compatible glue for joining ISOPIPE TC, ISOPIPE TR and ISOPIPE HT-HF insulation.

Description	Packaging
	Unit/ Ctr
ISOGLUE HT 150 250 ml with brush	20
ISOGLUE HT 150 500 ml with brush	12
ISOGLUE HT 150 1000 ml with brush	12

Units per carton can be amended without notification.

ISOCLAMPS

Eliminating Insulation Gaps

ISOCLAMPS are used to eliminate insulation gaps and reduce the possibility of thermal bridge, during the support of the insulated tubing (made by collar or metal bracket), in refrigeration or heating installations. They are suggested for applications where the temperature is between **-45°C to 105°C**.

Type of Material: Polyurethane (PU) foam with rubber insulation on both sides and PVC covering, with self-adhesive.

Available in thickness of: **13, 19, 25 & 32 mm** and pipe diameters up to **139 mm**. Other sizes available upon request.



Delivered with or without metal clamps. The metal clamps are M8 - M10.

ISOCOVER

Insulation Protection Covering

ISOCOVER is a special insulation protection covering against UV Radiation and mechanical damages.

Available in **SOLAR, HP, UV PLUS** and **HEAVY DUTY (HD)**.



Exterior Use

Description	Length	Width	Packaging
	m	mm	Unit/Crt
Solar	10 m	1 mm	1
Solar	25 m	1 mm	1
UV PLUS Pet-Al-Pe	10 m	1 mm	1
UV PLUS Pet-Al-Pe	25 m	1 mm	1
HEAVY DUTY Pet-Al-PVC	10 m	1 mm	1
HEAVY DUTY Pet-Al-PVC	25 m	1 mm	1

ISOCOVER SOLAR is available in Silver, Black & White Colour. Units per carton can be amended without notification.



Ideal solution for insulation protection in confined working areas and for already installed pipe systems

3.1 Important Information

3.1.1 Terminology

- **Insulation:** Isopipe Rubber closed cell flexible material in tubes or sheets
- **Pipe-line:** is the main body of pipe work, can be copper, steel or plastic or composite pipes
- **Joints:** screwed, welded, valves or any other part used to join pipe-lines
- **Pipe size:** commonly referring to the external diameter of pipe
- **Internal Tolerance:** referring to the min and maximum tolerances within the internal diameter of the insulation (di)
- **Clutch:** the act of clamping a sliced insulation over a pipe
- **Insulation surfaces:** the smooth flat side of the insulation, defined by length and width
- **End:** is the thickness side of the insulation (picture), defined by thickness (Th)
- **Fitting cover:** cut, slit and formed into shape parts of insulation, used for Joints and bends
- **Touch - Dry:** After applying glue, the point in time where the solvent has evaporated and the glue partly dried, to a point when touched (finger) it will not come-off(stick) to the finger. Can range between 3-10 minutes depending on temperature and humidity
- **Line temperature:** the temperature of the liquid inside the pipe (t)
- **Ambient temperature:** the environmental temperature surrounding the pipe (ta)
- **Relative humidity:** the level of humidity surrounding the pipe (h)

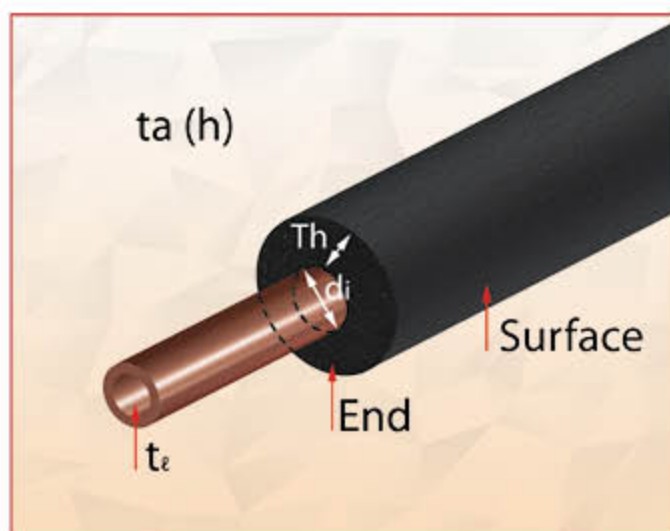

3.1.2 Tool Kit



1. Tape measure



2. Calipers

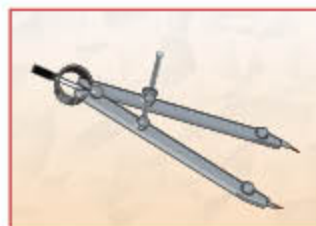

3. Compass



4. Knife



5. Brush



6. Meter box or angle diagram, for cutting angles



7. Spatula



8. ISOTAPE



9. ISOGLUE



10. Rivets

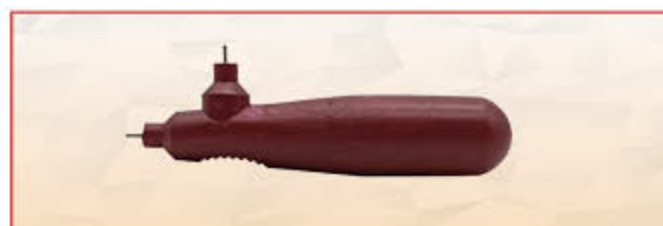

11. Rivet Tool

3.1 Important Information

3.1.3 Important Notes Before Applying Insulation

1. Always use the proper size insulation depending on application parameters, i.e. pipe size, fluid temperature, ambient temperature, relative humidity, and assure that the internal tolerances of the pipe are appropriate to the pipe been insulated. i.e. a pipe of External diameter 15mm would require internal diameter of 16mm 17,0mm, ensuring easy application and snug fit.

External pipe diameter	The ideal tolerances of insulation above the external diameter of the pipe
Φ 6 - Φ 64	+1,0mm - 2,0mm
Φ 67 - Φ 89	+1,0mm - 3,0mm
Φ 101 - Φ 139	+2,0mm - 4,0mm

2. Never stretch or compress **ISOPIPE** insulation.
3. Never insulate pipe-work that is in operation.
4. Use clean **ISOPIPE** insulation on clean and dry pipe-work remove any water, powder, dust, dirt or oil from both insulation and Pipe.
5. Never Insulate 2 pipes together within the same insulation and always allow gap of at least 20mm between insulated pipelines for free air circulation.
6. Seal all seams, valves, and joints. Do not allow open ends.
7. Use sharp knives and fresh glue.
8. Use adequate anti-corrosion protection on steel surfaces.
9. Common Fastening tape is not recommended as protective cover.
10. For outdoor applications, there are 3 types of rubber insulation protection available.
 - **SOLAR Covering** (See page 10)
 - **UV PLUS Covering** (See page 11)
 - **HEAVY DUTY (HD) Covering** (See page 11)
11. For indoor applications use **HP Covering** (See page 10)

3.1.4 ISOPIPE COVERINGS

General instructions

1. When you cut and join an **ISOPIPE COVERING**, avoid placing the joints of the sections towards the sun, to prevent direct contact with UV radiation.
2. When using/ installing **SOLAR, HP, UV PLUS** or **HEAVY DUTY** protection, use the appropriate tape, **ISOTAPE series** or **ISOCOVER series** (See Section 2.3, Pages 12-13 & 15), to secure the sealing.
3. When using/ installing **UV PLUS Covering**, pay attention, so that no air will be trapped inside the joints. Follow the instructions below:
 - Peel off the protective release film (yellow colour).
 - Use **ISOPIPE** Spatula to prevent the air trap during the joint procedure.
 - Use **ISOCOVER** tape to seal the joint.

The same instructions applies for **SOLAR & HP Coverings** by using the appropriate tape series (See page 18).

4. When using/ installing **HEAVY DUTY Covering**, follow the instructions below:
 - Peel off the protective release film (yellow colour).
 - Use **ISOPIPE** Spatula to avoid creating any air bubbles during the joint procedure.

Since **HEAVY DUTY Covering** is a "hard" cladding, it is really important to use Rivet Tool and Rivets, to avoid unsealing. Please follow the instructions below by choosing a or b:



- a. Punch a hole into the foil with the rivet tool, then plug the rivet into the metal tip of the tool and push it into the hole.

- b. Place the rivet tool, with the metal tip, into the rivet and push the rivet directly through the foil.

Notice:

1. Rivets should be placed between 100 to 150mm apart. However, when cladding takes place over short lengths, for example 200mm, ensure the ends of the jacket are well secured; and place another rivet in the middle. 
2. Do not punch the rivet too close to the edge of the jacket as it may break. Allow a minimum of 10mm distance. Pay also attention to the cold temperatures; it's best to firstly test on some scrap material and then on the finished jacket.

After finishing, for better aesthetic result, use **ISOCOVER** tape.

The same instructions of **HEAVY DUTY Covering** applies for **ISOCOVER HEAVY DUTY Pet-AI-PVC**.

3.1 Important Information

3.1.5 ISOGLUE

General instructions

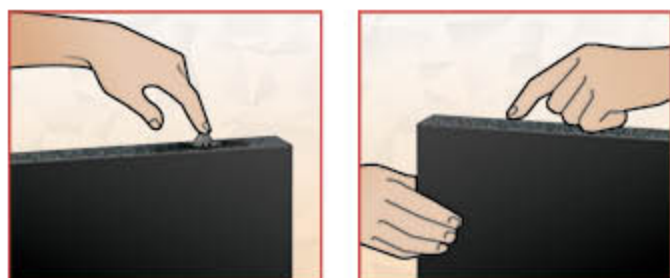

1. Apply an even layer of glue on both ends of insulation
2. Allow to touch-dry
3. Bring together firmly.

Note

ISOGLUE has a black colour which gives a perfect visual result after applying

- Approximately 200ml needed per square meter (m²) of gluing.
- It is important that the layer of glue is even, without formed blots, as this may cause crystallization and not proper bonding.
- **ISOGLUE** is flammable, so keep away when soldering or torching.
- Keep away from flame, sparks and heat.
- Always, keep glue container tightly closed to prevent evaporation.
- Isogluce bonds immediately upon contact, so ends must be put together accurately.
- Allow for 36 hrs before operation (especially for hot temperature).
- Always keep cans tightly sealed, preferably use fresh glue and in small cans to avoid risk of glue thickening.
- Stir glue before opening.
- The tack time for **ISOGLUE** is from four (4) to ten (10) minutes, depending on temperature and humidity. The maximum adhesive performance is achieved when the glue's solvent has evaporated. This can be practically detected by touching the surface with a finger. If the glue does not stick to the finger, and the glue does not feel sticky, then the joint may be closed.
- The best installation temperature is between 15-20 degrees.
- In cold temperature less than 5 degrees warm glue up in bucket of hot water.
- For cold pipe applications only, it is recommended to seal (glue) the pipe section ends onto the pipeline.

3.1.6 Applying ISOTAPE & ISOCOVER

Measuring the circumference: When using a tape measure, make sure to allow for considerable length equivalent to cover the thickness of the insulation itself. A practical approach is to use a strip of insulation of the same thickness to measure circumference and mark where the two ends overlap.



When applying any type of tape, use **ISOPIPE** Spatula to avoid creating any air bubbles during the joint procedure.

Notice:

In the end of any installation, it is really important to use the appropriate tape for each insulation especially when using Coverings.

Covering	Tape
SOLAR	ISOTAPE SOLAR POLYMER
	ISOTAPE PVC
HP	ISOCOVER HP
UV PLUS	ISOTAPE UV PLUS Pet-Al-Pe
	ISOCOVER UV PLUS Pet-Al-Pe
HEAVY DUTY	ISOTAPE UV PLUS Pet-Al-Pe
	ISOCOVER HEAVY DUTY Pet-Al-PVC

Notice:

When using ISOPIPE TC, ISOPIPE TR, ISOPIPE HT-HF use ISOTAPE Self-Adhesive.

The same instructions apply when using a different product range including Slit & Seal, ISOROLLS, ISOSHEETS, ISOSYSTEM by using the appropriate tape.

The tape should be applied over the glued ends/joints.

For ISOCOVER HEAVY DUTY Pet-Al-PVC installation please advise page 17.

3.2 Pipes

3.2.1 Insulation on New Pipes

The following instructions also apply with ISOPIPE TC/ HT-HF, ISOPIPE TC/HT-HF SOLAR, ISOPIPE TC HP, ISOPIPE TC/HT-HF UV PLUS, ISOPIPE TC/HT-HF HD.



1. Wipe clean any dust, dirt or grease from the pipe.
2. Cut the insulation as long as or slightly longer than the length of the pipe-section been installed.
3. Slide the ISOPIPE insulation gently through the pipe; push the insulation over the pipe rather than pull

For pipes over 114mm it is recommended to use ISOROLLS, ISOSHEETS or ISOSYSTEM.

Joining lengths of ISOPIPE

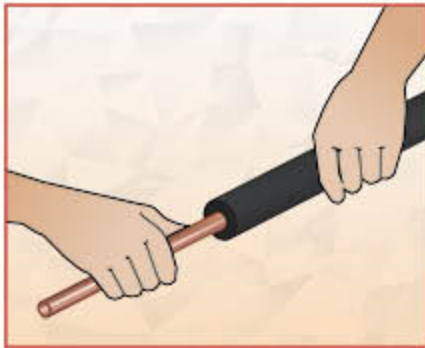

1. Apply glue on both ends of insulation.
2. Allow glue to touch dry.

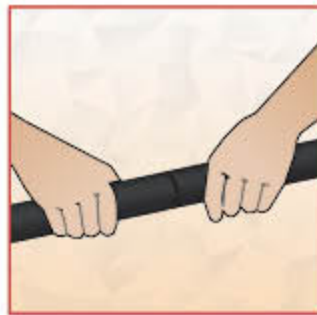

3. **Bring together firmly.** For additional sealing at the ends of pipe sections, for cold applications only to reduce risk of condensation, seal by gluing the insulation onto the pipe.

3.2.2 Bends

ISOPIPE insulation is very flexible and can easily be slid over bends and turns.

However, on sharp bends and joints kinking and stretching of insulation may occur which will affect the insulation performance.

It is advised in this instance to cut and glue pipe as picture below, relieving the stress on the pipe at sharp bends.



When using SOLAR, HP, UV PLUS & HEAVY DUTY protection follow the same instructions and upon finishing use the appropriate tape (See Section 3.1.6, Page 18).



3.2 Pipes

3.2.3 Installation on Existing Pipes

a) The snap on method

The following method is used for applying insulation on already installed and connected pipes, using ISOPIPE TC/ HT-HF/ TR, ISOPIPE TC/HT-HF SOLAR, ISOPIPE TC HP, ISOPIPE TC/HT-HF UV PLUS, ISOPIPE TC/HT-HF HD.

1. Use a sharp knife to slit the ISOPIPE lengthwise on one side.
2. Cover the pipe



3. Apply ISOGLUE adhesive on both slit surfaces. Keep the adhesive-covered sides apart for drying.
4. Press both sides together firmly in order to connect them all the way.
5. If the insulation sticks to the pipe, loose the insulation as shown.

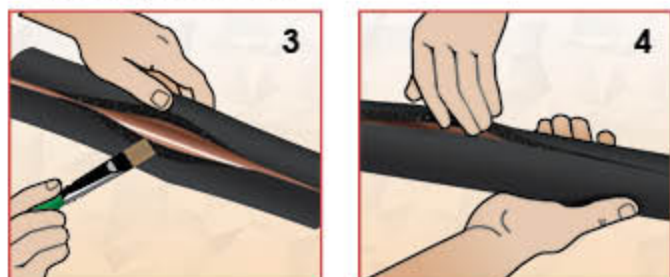

6. When the adhesive has dried, press insulation together to ensure a tight connection.
7. In a multi-layer insulation work, apply ISOPIPE where possible.

Note

ISOPIPE Slit & Seal is also available, which is pre-cut insulation with or without adhesive, for easier application.



b) Installation using ISOPIPE TC/ HT-HF Slit, ISOPIPE TC/ HT-HF Slit & Seal, ISOPIPE TC/ HT-HF SOLAR Slit & Seal

The following method is used for applying insulation on already installed and connected pipes.

Note

SLIT: Synthetic rubber installation, lengthwise pre-slitted.

SLIT & SEAL: Synthetic rubber installation, lengthwise pre-slitted with self-adhesive plus black overlap. It is pre-cut at angle to ensure larger bonding surface, better adhesion and less risk of heat loss. Slit & Seal reduces significantly application and installation time and costs.

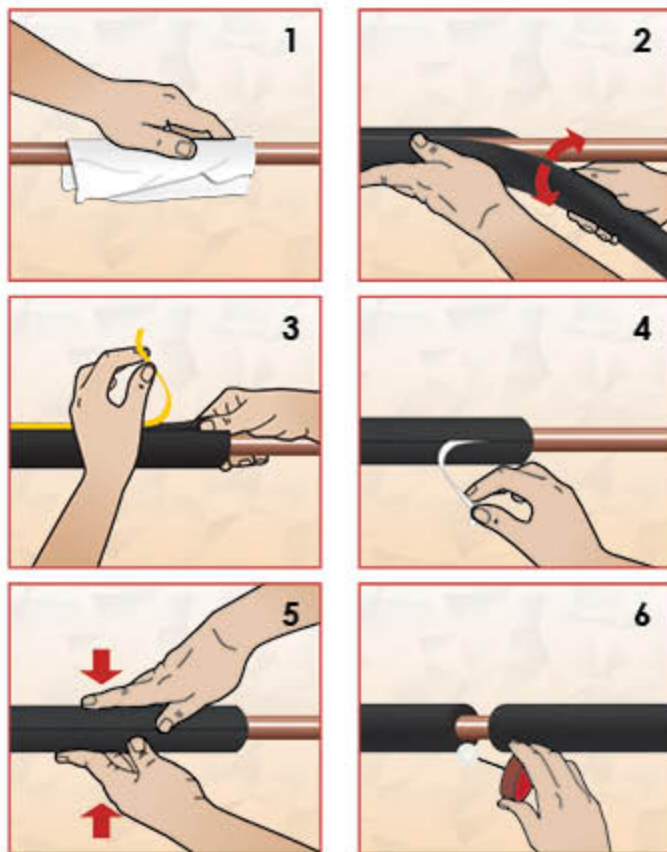

1. Clean well the pipe's exterior surface.
2. Place the insulation over the pipe.
3. Lift the inner protective release film.
4. Pull out the protective release film while holding at an angle.
5. Bring both sides of the insulation firmly together. Release the film from the overlapping tape and cover the slit.
6. Apply ISOGLUE on the ends to join more insulation pieces. Then, press firmly together to connect them.

When using Slit & Seal with SOLAR protection follow the same instructions and upon finishing apply the appropriate tape (See Section 3.1.6, Page 18).

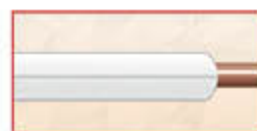

3.2.4 Installation on TWIN Pipes

The following instructions apply with ISOSOL TWIN & SOLAR COVERING TWIN.

1-2. Using a small knife, cut the thinner part, exactly in the middle of the film, between the tubes, approximately 2 cm (see pictures 1 and 2).

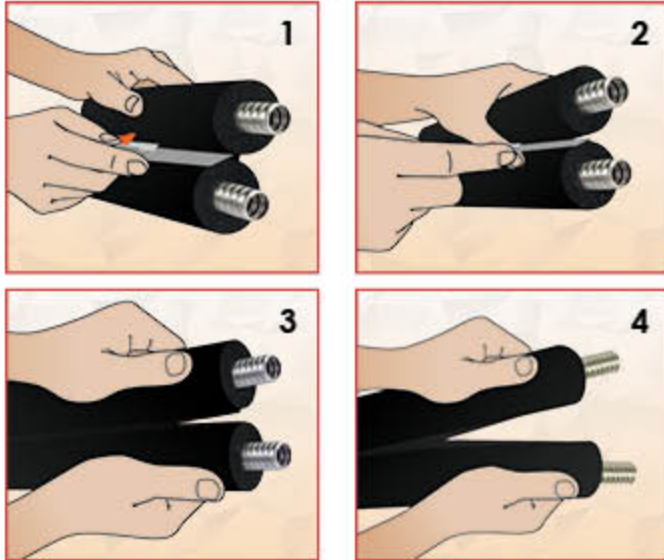

3-4. With your hands split the tubes until the desired length (see pictures 3 and 4).

At the point we need to put an end either at the beginning or at the end, of the bobbin, a tape should be inserted, in order to prevent the tube from separating.

3.2.5 Installation on INOX Fittings

a) Using the INOX Fittings

1. Hold the stainless steel pipe.
2. Place the female brass union around the INOX pipe.

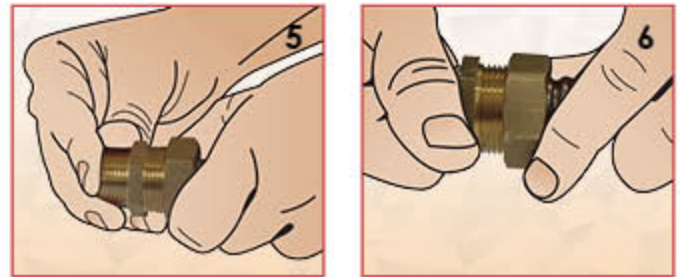
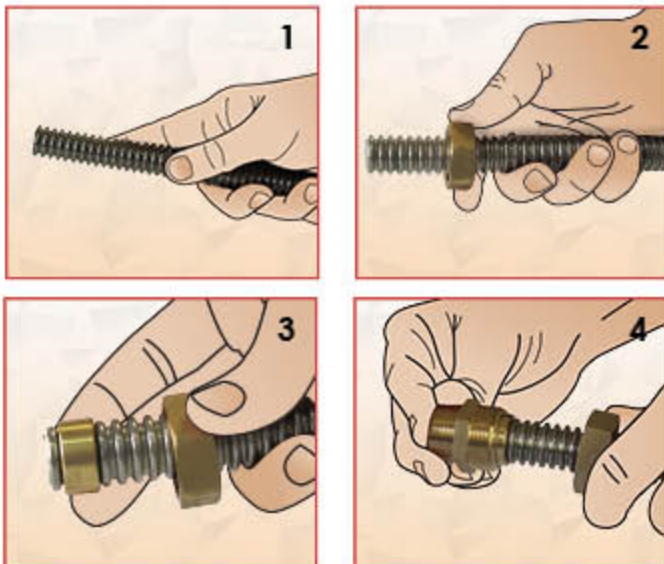

3. Place the double crecent ring at the pipe's edge while leaving one corrugation.
4. Above the ring, place the male union.
5. Connect the male with the female brass union.
6. Ready!

b) Female Brass Nut with INOX Ring

1. Hold the stainless steel pipe.
2. Place the female brass nut around the INOX pipe.

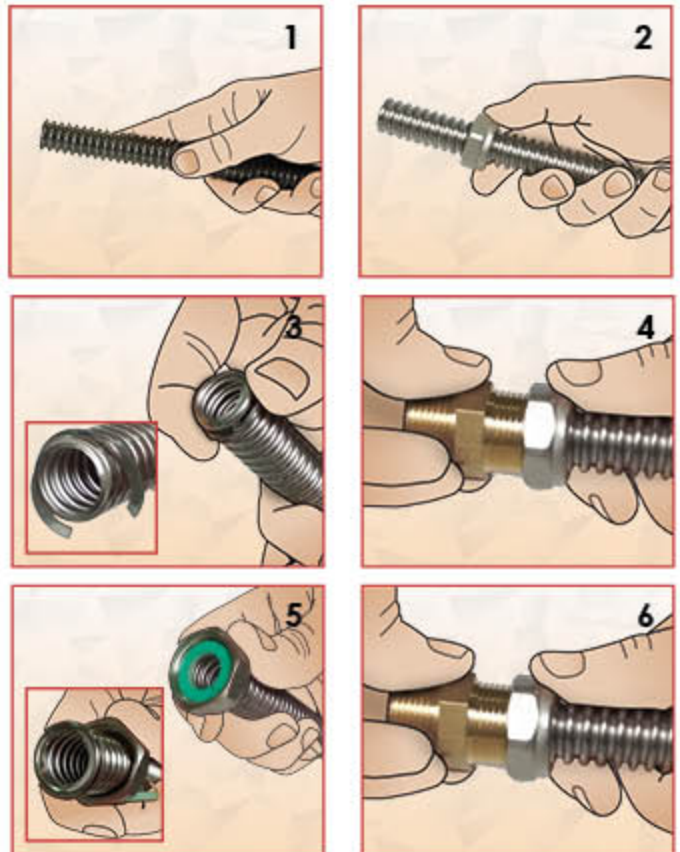

3. Place the INOX ring one corrugation below the upper edge of the pipe and then press its edges together.
4. Bring the female brass nut at the edge of the pipe until it reaches the INOX ring, and connect the special male nipple in the nut, so as to create a flat surface on the pipe's edge.
Note: This process should be completed cautiously, since it is important to have a flat surface on the pipe's edge, which will prevent future hydraulic failures.
5. Remove the special male nipple and place the klingerit gasket inside the female brass nut.
6. Then place any male fitting. Ready!

3.3 Fittings, Connectors

3.3.1 General Information

The following instructions also apply with ISOPIPE TC/ HT-HF, ISOPIPE TC/HT-HF SOLAR, ISOPIPE TC HP, ISOPIPE TC/HT-HF UV PLUS, ISOPIPE TC/HT-HF HD.



1. Bring the insulated-pipes sections together to be soldered- fitted.
2. Gently pull back the insulation and hold away with clamps, apply clamps on pipes and never on insulation.
3. Solder or fit pipes
4. After fitting has cooled, remove clamps and bring insulation back to position
5. Test the line
6. Apply joint over fitting and join with **ISOGLUE**. See forming Joints

For 90 degree bends, T-Joints and all other joints, cut, slit and form shape of joint (right angle, T-joint etc), glue joint together and with main pipe insulation.

3.3.2 T-Joints

The following method is used for applying insulation on already installed and connected pipes.

For similar dimension pipes, soldered joints or sweat fittings.

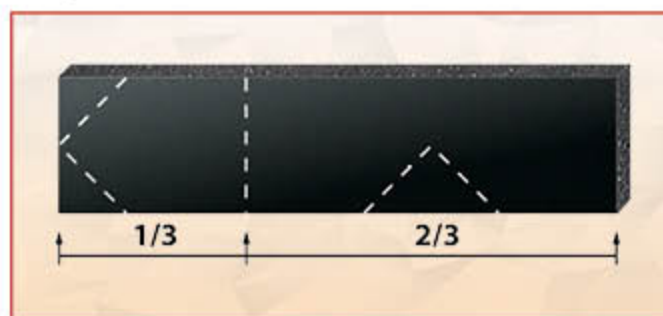

1. Separate by cutting from the same pipe a 1/3 length.
2. From the short length cut a 45% point.
3. From the long length cut a 45% indent.
4. Apply glue on the angled cut ends of both lengths, allow to touch dry, and form the T-Joint.
5. Carefully slice the T-joint in half, and place on pipes.

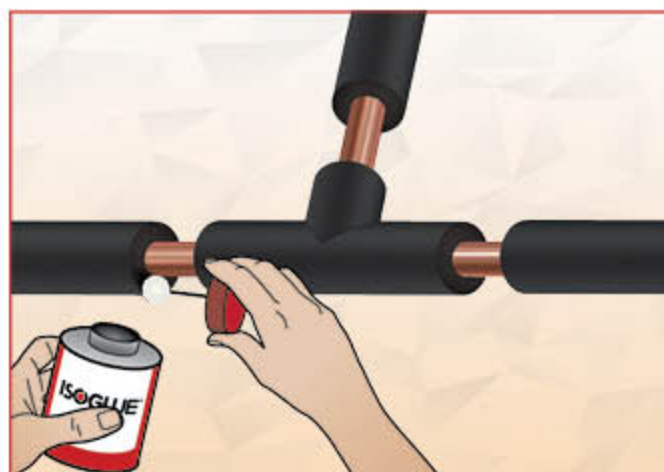
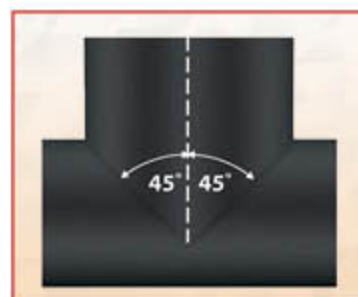

3.3 Fittings, Connectors

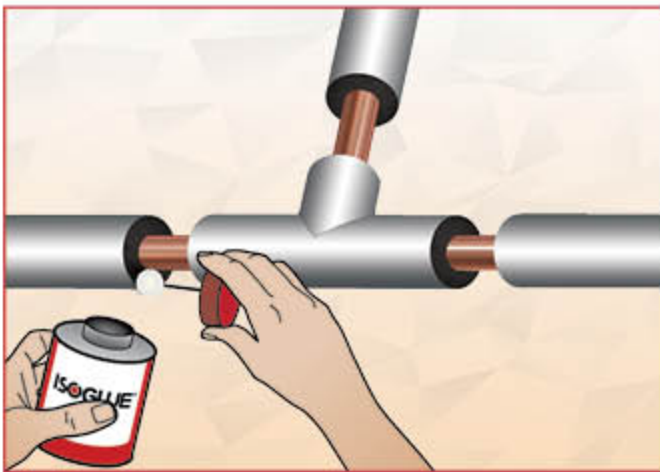
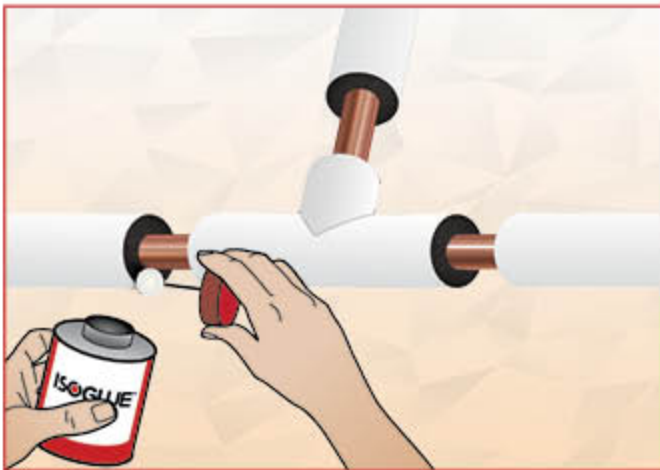

When using **SOLAR, HP, UV PLUS & HEAVY DUTY** protection follow the same instructions and upon finishing use the appropriate tape (See Section 3.1.6, Page 18).

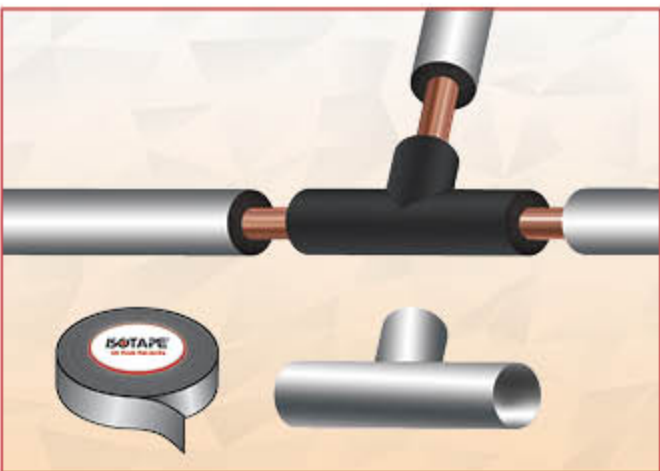

In installations where **Heavy Duty** covering is used, when having to insulate a T-joint, use **ISOPIPE TC** to insulate the joint and cover it with jacketing systems of Tees (Alu Covering) with the appropriate dimension by following the same instructions.

Alternative method for different diameter pipes

1. With a piece of the pipe (cut-off), punch (drill) out a hole in the insulation.
2. Slice the insulation and clutch over pipe top vertical part of T-joint.
3. To join with the horizontal pipe, cut a indented curve from the insulation, with a sharp knife.
4. Slice insulation if necessary.
5. Apply glue on ends and allow to touch dry.
6. Bring horizontal insulation to meet with vertical insulation.



3.3.4 Bends

The following instructions also apply with **ISOPIPE TC/ HT-HF/ TR, ISOPIPE TC/HT-HF SOLAR, ISOPIPE TC HP, ISOPIPE TC/HT-HF UV PLUS, ISOPIPE TC/HT-HF HD.**

Alternatively where the joints diameter is different from the pipeline or for screwed fittings.



1. Bring line insulation as close as possible to joint.
2. Measure the outer diameter of the insulated pipe line (a).



3.3 Fittings, Connectors

3. Choose a pipe insulation with an internal diameter to cover the insulated pipe line along with the joint.



4. Measure and cut an insulation length to cover besides the joint also the insulation and overlap it by at least 25mm.



5. Form a corner.

6. Clutch insulation over joint and insulated pipe.



7. Apply glue on end and on the overlapping surface.



When using SOLAR, HP, UV PLUS & HEAVY DUTY protection follow the same instructions and upon finishing use the appropriate tape (See Section 3.1.6, Page 18).



Please use the "ISOPIPE Cutting Template", which you will find printed in the back of the 2 meter ISOPIPE box, to easily create bends.



- **Bend with 45° angle**
Yellow line shows the cut position.

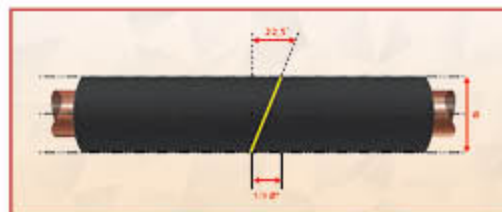

- **Segment Bend with 1 middle part (22,5°)**
Yellow line shows the cut position.

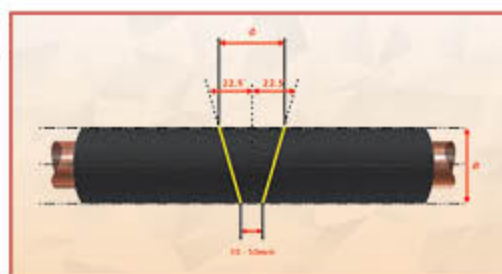

- **Segment Bend with 2 middle parts (15°)**
Yellow line shows the cut position.

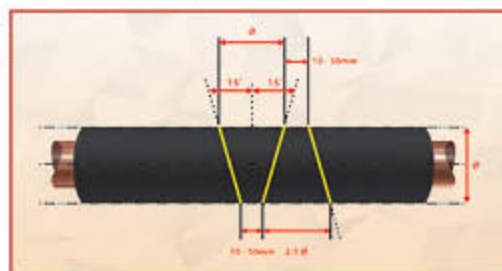
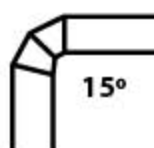

- **Segment Bend with 3 middle parts (11,25°)**
Yellow line shows the cut position.

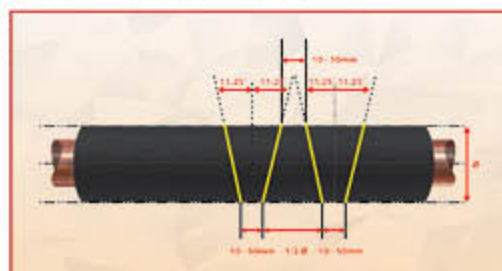

- **Crosspiece Joint**

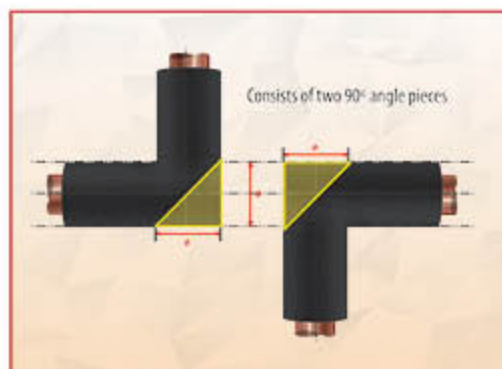
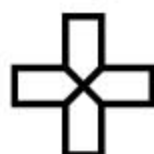

3.3 Fittings, Connectors

3.3.5 Curves

The following instructions also apply with ISOSHEET or ISOROLL TC/HT-HF, ISOSHEET or ISOROLL TC/HT-HF SOLAR, ISOSHEET or ISOROLL TC HP, ISOSHEET or ISOROLL TC/HT-HF UV PLUS, ISOSHEET or ISOROLL TC/HT-HF HD.



1. Measure the length of the internal curve (a).



2. With the assistance of a compass, at the length of the internal curve, draw out and cut the inner arc.

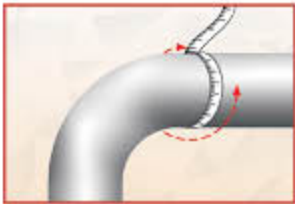

3. Measure the circumference of the pipe and mark the half point.

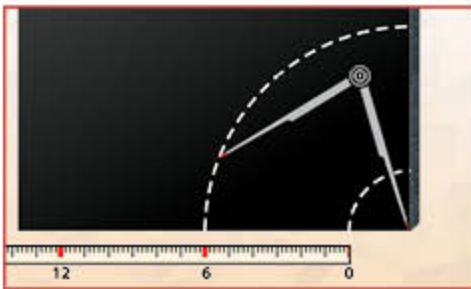
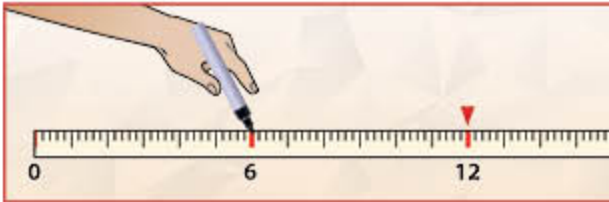

4. With the assistance of a compass, at the length of the half point of circumference, draw out and cut the outer arc.



5. Using the cut-out arche piece, carefully draw and cut another copy of the same dimension.



6. Apply glue on both ends of the long arced sides, allow to touch dry and bring pieces together, beginning from the edges.
7. Apply glue on both ends of internal arc, allow to touch dry.

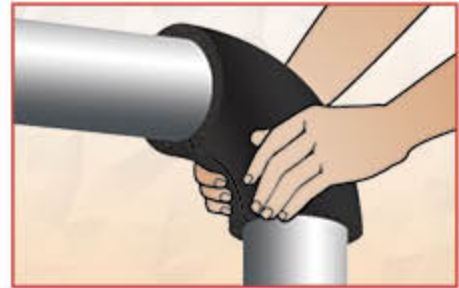

8. Bring around pipe and join.
9. Trim insulation if necessary.

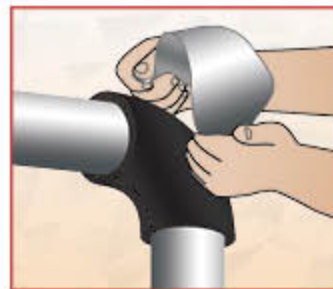

In installations where **Heavy Duty** covering is used, when having to insulate a curve, use **ISOPIPE TC** to insulate it and cover it with jacketing systems of Elbow (Alu Covering) with the appropriate dimension by following the same instructions.



When using **SOLAR, HP, UV PLUS & HEAVY DUTY** protection follow the same instructions and upon finishing use the appropriate tape (See Section 3.1.6, Page 18).

3.3 Fittings, Connectors

3.3.6 Joints

The following instructions also apply with ISOSHEET or ISOROLL TC/HT-HF, ISOSHEET or ISOROLL TC/HT-HF SOLAR, ISOSHEET or ISOROLL TC HP, ISOSHEET or ISOROLL TC/HT-HF UV PLUS, ISOSHEET or ISOROLL TC/HT-HF HD.



1. Bring line insulation as close as possible to flange.



2. Measure the outer diameter of the insulated pipe line.

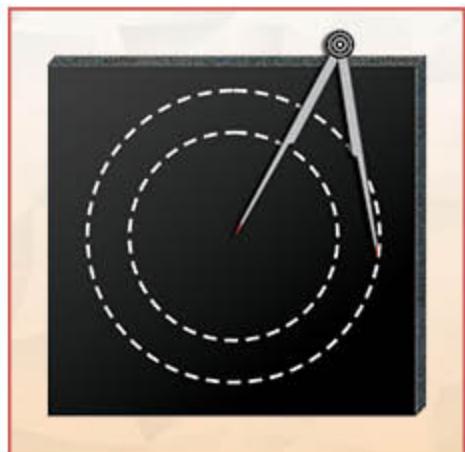

3. Measure the outer diameter of the Joint/flange.
4. With the use of a compass, draw and cut out 2 side pieces.
5. Cut an opening, and bring around pipe and adjacent to joint/flange.
6. Measure the circumference of the Joint/flange and cut.

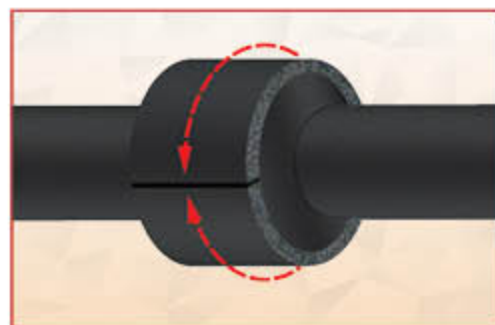

7. Measure and cut the required width to cover the joint and extend over the side pieces.
8. Apply glue on ends, allow to touch dry and bring around Joint.

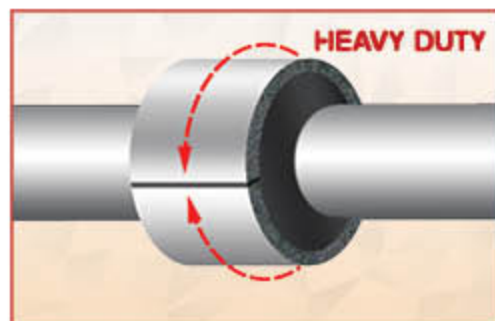
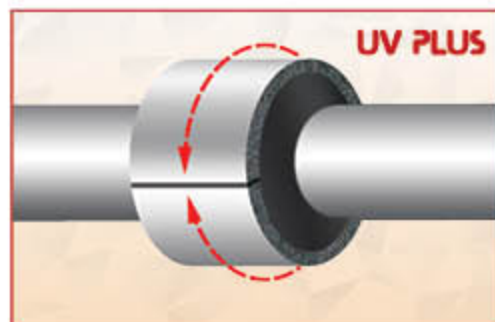
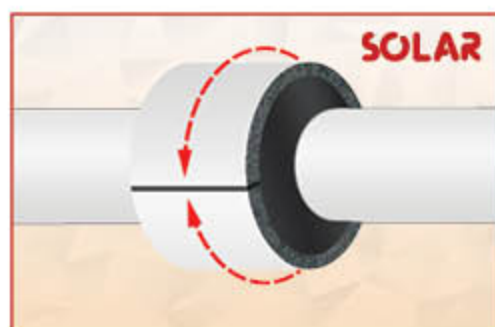

Aluminium Tape is considered necessary in installations that use insulation with **UV PLUS** or **HD Covering**. The tape should be applied over the glued ends/joints (See Section 3.1.6, Page 18).

3.3 Fittings, Connectors

3.3.7 Valves

The following instructions also apply with ISOSHEET or ISOROLL TC/HT-HF, ISOSHEET or ISOROLL TC/HT-HF SOLAR, ISOSHEET or ISOROLL TC HP, ISOSHEET or ISOROLL TC/HT-HF UV PLUS, ISOSHEET or ISOROLL TC/HT-HF HD.

Modifications might be needed, since shape and design may vary.

1. Cut **ISOPIPE** pieces the same diameter as the flanges and mount them on the flange and valve areas.
2. Use scrap stripes to build the body of the valve until it takes the same dimension as the flanges. Use **ISOGLUE** to adhere the stripes directly on the valve body.
3. Wrap a strip around the body of the flange to measure the length (A) of the sheet needed.
4. Cut the **ISOPIPE** sheet for the valve body. Length (B) is the distance between the outer edges of the pieces, located at the flanges. Cut a semicircle from each end of the sheet (C).
5. Wrap the cut out sheet around the valve body. After applying **ISOGLUE**, press firmly together.
6. Use next cut-out piece to insulate the bonnet area.

Take the measurements as follows:

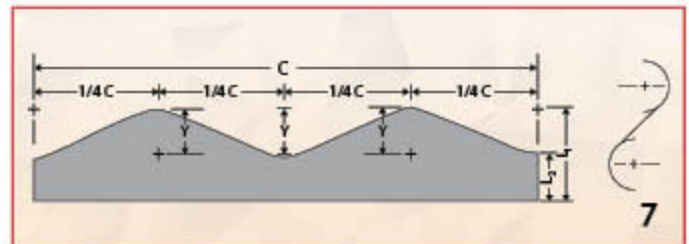
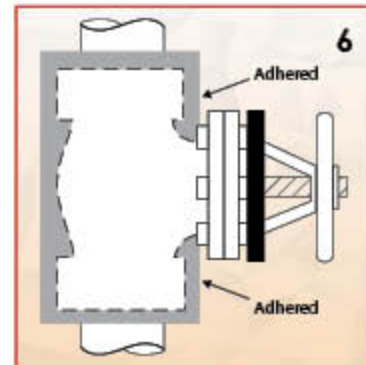
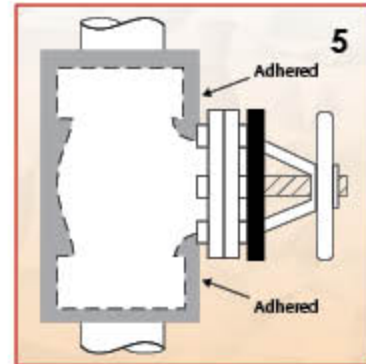
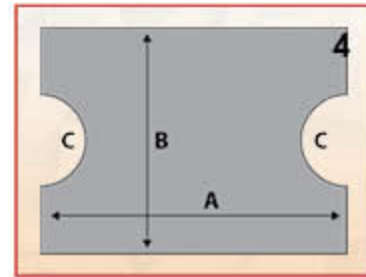
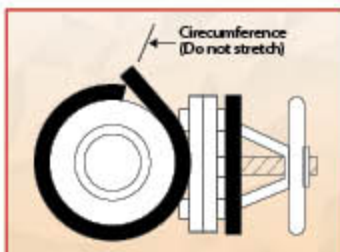
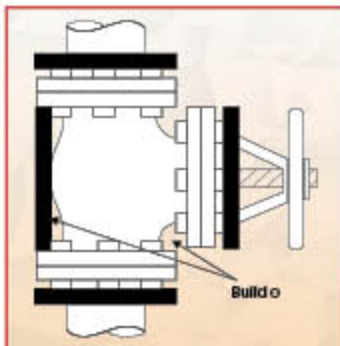
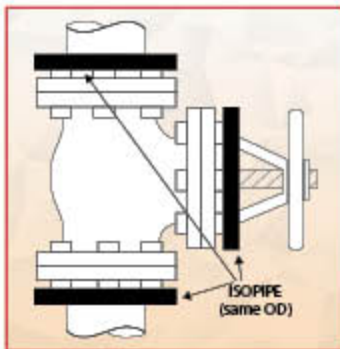

C – Overall length. Wrap a strip around the bonnet

L1 – Distance from the outer surface to the approx. middle of the valve body.

L2 – Distance from the outer surface to the closest surface of the valve body

Y – Difference between L1 – L2. Bonnet is cut in the dimension CxL1. Divide the rectangle piece in 4 equal sections and mark the short and the long length, beginning and ending from the short length. Cut carefully curving wave-like between the lengths. Apply **ISOGLUE** and wrap it around the neck of the valve. Finally, seal all the contact edges carefully.

3.3 Fittings, Connectors

3.3.8 Multilayer Insulation Pipes

The following instructions also apply with ISOPIPE TC/ HT-HF, ISOPIPE TC/HT-HF SOLAR, ISOPIPE TC HP, ISOPIPE TC/HT-HF UV PLUS, ISOPIPE TC/HT-HF HD.

1. The inside diameter of the outer overlapping pipe should be enough to cover the maximum outside diameter of the inner pipe. If the maximum diameter of the inner pipe is too large, then ISOROLLS should be used.
2. Apply glue to entire surfaces of both the inner and outer pipe; allow to touch dry before positioning.

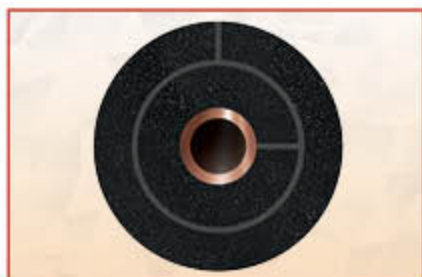

3.3.9 Installation On Concentric Reducers

The following instructions also apply with ISOSHEET or ISOROLL TC/HT-HF, ISOSHEET or ISOROLL TC/HT-HF SOLAR, ISOSHEET or ISOROLL TC HP, ISOSHEET or ISOROLL TC/HT-HF UV PLUS, ISOSHEET or ISOROLL TC/HT-HF HD.

1. Measure the height (h).

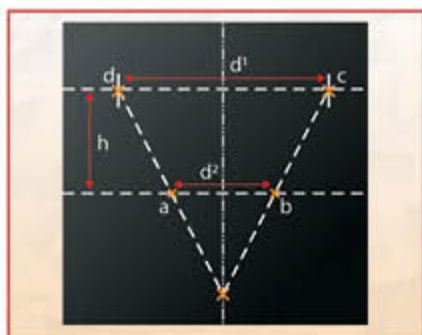
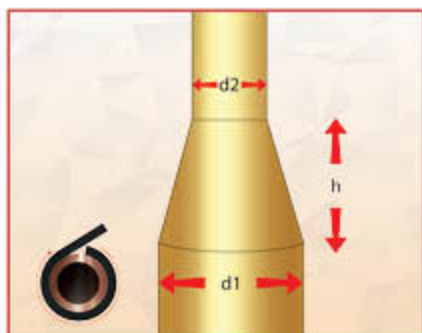

Measure the diameters of the smaller (d^1 = diameter + 2x insulation thickness) and of the larger pipe section (d^2 = diameter + 2x insulation thickness)

2. Mark a center line on the ISOPIPE sheet and place all the other measurement on the sheet as shown.
3. From the apex point, mark 2 arches (a-b and d-c)
4. Measure the circumference of the c1 (large pipe) and the c2 (small pipe).
5. Mark the final dimension of the insulation and cut it out.
6. Apply **ISOGLUE** on the cut-out edges and wrap firmly on the reducer's body.

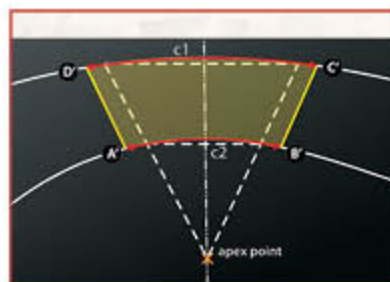
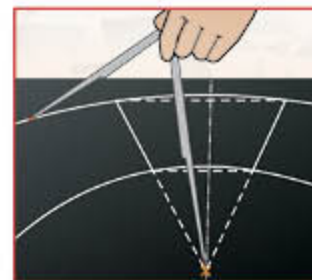

Aluminium Tape is considered necessary in installations that use insulation with **UV PLUS** or **HD Covering**. The tape should be applied over the glued ends/joints (See Section 3.1.6, Page 18).

3.3 Fittings, Connectors

3.3.10 Installation on Couplings

The following instructions also apply with ISOSHEET or ISOROLL TC/HT-HF, ISOSHEET or ISOROLL TC/HT-HF SOLAR, ISOSHEET or ISOROLL TC HP, ISOSHEET or ISOROLL TC/HT-HF UV PLUS, ISOSHEET or ISOROLL TC/HT-HF HD.

Insulate pipe until the coupling.

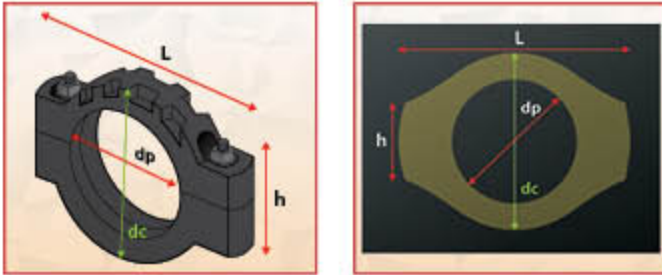

1. Measure the diameter
($dc = \text{diameter} + 2 \times \text{insulation thickness}$)
Measure the height of screws
($h = \text{height} + 2 \times \text{insulation thickness}$)
Measure the length (L)
2. Using $\frac{1}{2}$ of dc as the radius transfer a circular arc to the sheet and mark a horizontal center line.



From there mark the width.
On the ends mark the height (h) at 90° angle.
Connect the endpoints and mark an oval.
Mark the diameter of the pipe on the sheet to be used.
Use template to create a second oval.

3. Apply **ISOGLUE** adhesive on both ovals.
4. Measure the circumference of the oval and the distance over the outer face of both ovals.
5. Mark them on the sheet which will be used, cut them out and wrap firmly around the coupling.



3.3.11 Insulation On Pipe Supports

The following instructions also apply with ISOSHEET or ISOROLL TC/HT-HF, ISOSHEET or ISOROLL TC/HT-HF SOLAR, ISOSHEET or ISOROLL TC HP, ISOSHEET or ISOROLL TC/HT-HF UV PLUS, ISOSHEET or ISOROLL TC/HT-HF HD.

Pipe supports should be also insulated, to prevent condensation.

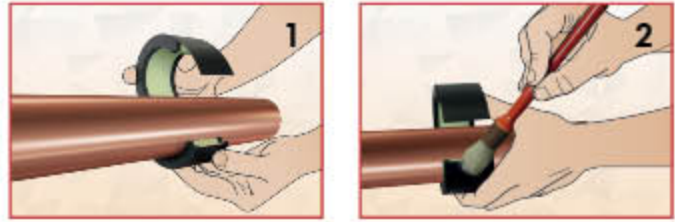

1. Open the **ISOPIPE Clamp** and place/ install it at the point where you will apply the support.
2. Coat with the special glue, **ISOGLUE** at the edges of ISOPIPE Clamp and close it.

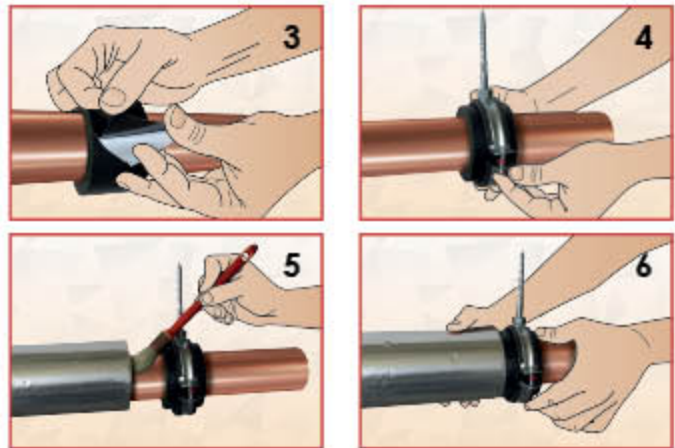

3. Seal the ISOPIPE Clamp with the adhesive tape which is located in the upper level of the **ISOPIPE Clamp**.
4. Place/ Install the support mechanism/ wood screw clamp above **ISOPIPE Clamp**.
5. Coat with the special glue, **ISOGLUE** at the edges of ISOPIPE insulation pipes.
6. Join/ Connect the ISOPIPE insulation with **ISOPIPE Clamp** in order to complete the installation.



Important: The thickness of the **ISOCLAMP** should be the same as that of the ISOPIPE isolating material.

ISOCLAMP holders are available in **SOLAR**, **UV PLUS** & **HEAVY DUTY**.



3.3 Fittings, Connectors

3.12 Installation on Strainers, Strainer Valves, Inclined Seat Valves

The following instructions also apply with ISOPIPE TC/HT-HF, ISOPIPE TC/HT-HF SOLAR, ISOPIPE TC HP, ISOPIPE TC/HT-HF UV PLUS, ISOPIPE TC/HT-HF HD.

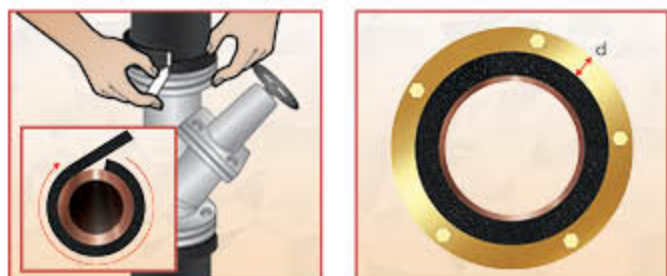

1. Insulate the pipe until the flange.
2. Measure the depth (d) of the flange ring.



3. Measure the circumference (b) of the insulated pipe.
4. Cut the strip needed. Apply ISOGLUE adhesive on both sides and cover the flange ring.

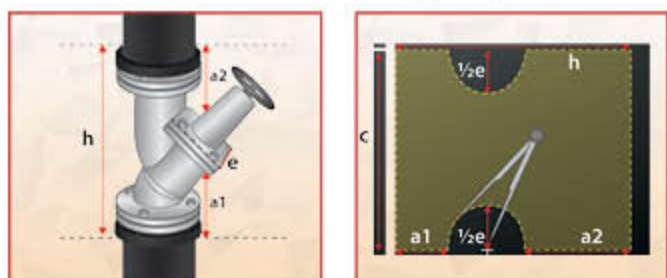

- 5.+6. Measure the distance (h), the distance a1 and a2, as well as the depth of the strainer (e) and the circumference of the rings (c).



7. Transfer the results on the sheet to be used and cut-out the required piece. Apply the ISOGLUE adhesive on the strainer body and wrap the sheet around the strainer.
8. Cut a ring and attach it at the end of the insulated section.

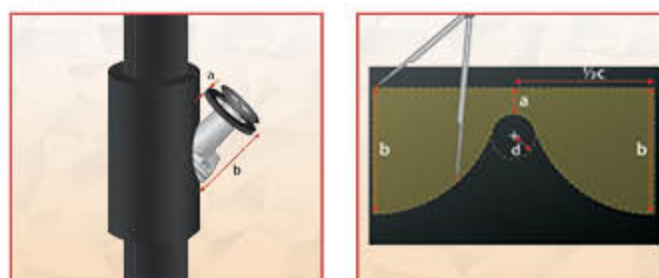

9. Measure the shortest (a) and the longest (b) distance from the ring to the strainer body.

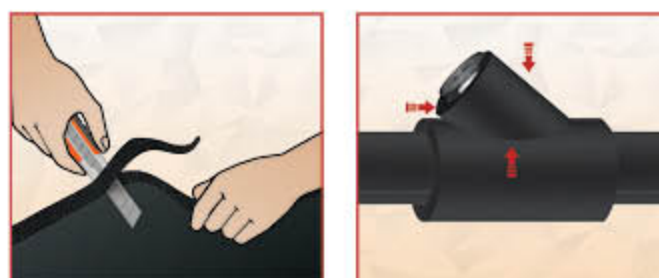

10. Measure the diameter (d) of the valve body.
11. Prepare and cut-out a sheet.
12. Apply with ISOGLUE and wrap around the valve body firmly.

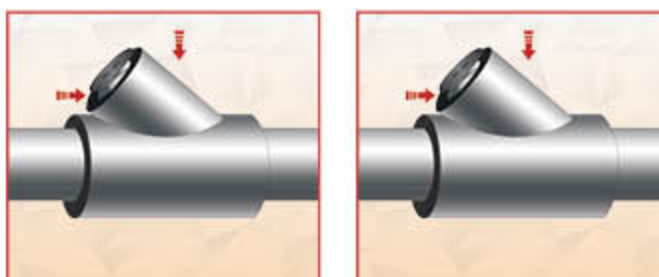

Aluminium Tape is considered necessary in installations that use insulation with **UV PLUS** or **HD Covering**. The tape should be applied over the glued ends/joints (See Section 3.1.6, Page 18).

3.4.1 On Large Pipes (over 114 mm)

a) Installation on pipes using ISOSHEETS

The following instructions also apply with ISOSHEET or ISOROLL TC/HT-HF, ISOSHEET or ISOROLL TC/HT-HF SOLAR, ISOSHEET or ISOROLL TC HP, ISOSHEET or ISOROLL TC/HT-HF UV PLUS, ISOSHEET or ISOROLL TC/HT-HF HD.

Using ISOSHEETS

1. Cut the sheet to the requested width (should fit easy around the pipe).
2. Apply **ISOGLUE** adhesive on both slit surfaces. Keep the adhesive covered sides apart for drying. Wrap the sheet around the pipe and press both end sides firmly together.
3. When insulating fittings, use already designed or reusable templates.
4. The complete cover of the fitting is formed by adhering two halves together at the long outer arc. Use **ISOGLUE** on both sides. Let it dry. Press both surfaces firmly together.

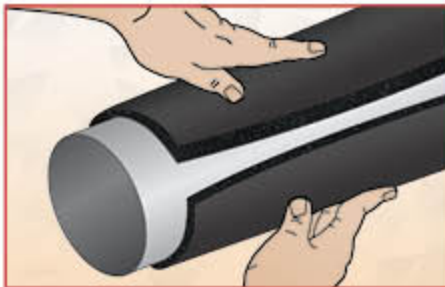

b) Using ISOSYSTEM (recommended for large pipes)

The ISOSYSTEM offers an efficient method of insulating.



45° angle cut for easy installation

- Already pre-cut to the dimensions of the pipe. Available up to Ø 1200!

1. No need to cut the sheet.
2. Apply **ISOGLUE** adhesive on both slit surfaces. Keep the adhesive-covered sides apart for drying. Wrap the sheet around the pipe.

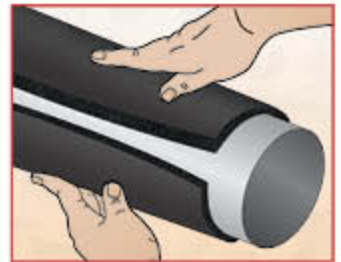

3. Align angle-cut edges and bring together, pressing firmly.
4. Drag palms slowly along joint, aligning and applying pressure.



Aluminium Tape is considered necessary in installations that use insulation with **UV PLUS** or **HD Covering**. The tape should be applied over the glued ends/joints (See Section 3.1.6, Page 18).

3.4 Sheets

3.4.2 On Flat Surfaces on Pipes (over 600mm using ISOGLUE)

The following instructions also apply with ISOSHEET or ISOROLL TC/HT-HF, ISOSHEET or ISOROLL TC/HT-HF SOLAR, ISOSHEET or ISOROLL TC HP, ISOSHEET or ISOROLL TC/HT-HF UV PLUS, ISOSHEET or ISOROLL TC/HT-HF HD.

It is recommended that only large thickness be used for large bore pipes.

1. Clean surfaces of insulation and surface; remove dust, water, dirt etc.
2. Measure correct dimensions length width allow an extra 5mm overlap, to allow adjacent insulation sheets to be pressed together.

For Ducts, cut the bottom side first, same width as duct, then cut the 2 side-pieces, so that they extend down over the edges of the bottom insulation. The Top piece should extend over the side insulation.



- a = width of duct + 5mm
- b = length of duct + 5mm + thickness of insulation
- c = width of duct + 5mm + 2 x thickness of insulation

3. Apply an even layer glue, on both surfaces first the Insulation sheet and then onto metal surface, with a brush or roller.



4. Allow glue to tack dry (3-10 min)

5. Line up insulation and press firmly to achieve a good bond.

6. Fix the 2 opposite side of the duct first, then the remaining sides, taking into consideration the thickness of the sheets already installed, and also allowing for compression between adjacent sheets.

7. Apply glue on edges.



3.4.3 On Flat Surfaces Using Self-Adhesive ISOROLLS, ISOSHEETS

The following instructions also apply with ISOSHEET or ISOROLL TC/HT-HF, ISOSHEET or ISOROLL TC/HT-HF SOLAR, ISOSHEET or ISOROLL TC HP, ISOSHEET or ISOROLL TC/HT-HF UV PLUS, ISOSHEET or ISOROLL TC/HT-HF HD.

1. Clean surfaces of insulation and surface; remove dust, water, dirt etc.
2. Measure correct dimensions length width.

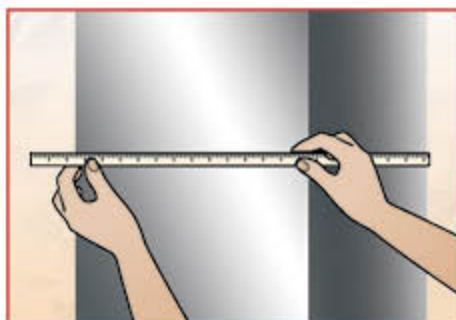

3. Peel back plastic cover.
4. Line up insulation and press firmly to achieve a good bond.



5. Keep insulation in line, pulling and removing plastic cover.
6. At joints between sheets/rolls allow an extra 5mm overlap, to allow adjacent insulation sheets to be pressed together.

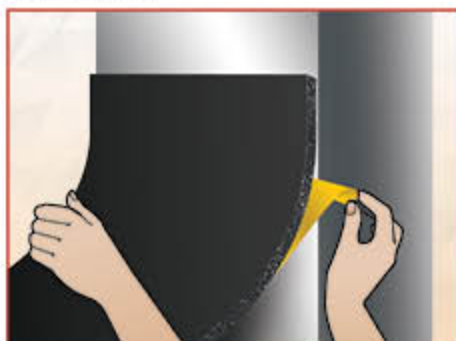

It is highly recommended, for best results to use the appropriate type of ISOTAPE according to the insulation's surface (See Section 3.1.6, Page 18).

Aluminium Tape is considered necessary in installations that use insulation with **UV PLUS** or **HD** covering. The tape should be applied over the glued ends/joints (See Section 3.1.6, Page 18).

3.4.4 For Tanks with Dome Top

The following instructions also apply with ISOSHEET or ISOROLL TC/HT-HF, ISOSHEET or ISOROLL TC/HT-HF SOLAR, ISOSHEET or ISOROLL TC HP, ISOSHEET or ISOROLL TC/HT-HF UV PLUS, ISOSHEET or ISOROLL TC/HT-HF HD.

1. Measure, cut and apply sheet as large-bore pipes.
2. Measure the length-diameter of the oval top.
3. Cut a circle out
4. Apply glue on surface of insulation and on tank top. Also, apply glue on insulation ends.
5. Put insulation in place and press firmly on Tank and join with side-insulation.

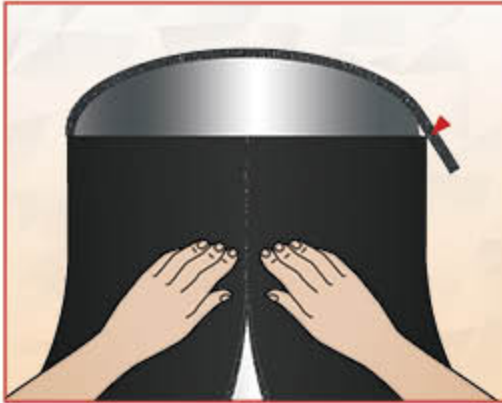

Aluminium Tape is considered necessary in installations that use insulation with **UV PLUS** or **HD** covering. The tape should be applied over the glued ends/joints (See Section 3.1.6, Page 18).

Notes

A series of horizontal dotted lines for taking notes.



The information included in this instruction manual should be used as a reference guide to dealing with most common insulation application. It is up to experienced installers to identify appropriate solutions to deal with the variety and complexity of the installation.

ISOPIPE S.A. & 3i International Innovative Insulation S.A. (3i S.A.), cannot be held liable for any defects occurring as a result of incorrect or installation of the insulation. The information and pictures contained in this booklet remain the property of ISOPIPE S.A. & 3i S.A., and may not be copied or reproduced without written permission.

ISOPIPE[®] S.A.

Rebuild the future!

www.isopipe.eu



GREECE

Head Office:

Nafpliou & Daskalogianni
144 52 Metamorfoosi Attikis
T.: +30 210 28 28 603
F.: +30 210 28 19 210
E.: export@isopipe.gr

Plant:

73rd km Nat. Road Athens -
Lamia
341 00 Ritsona Halkida
T.: +30 22620 89 800
F.: +30 22620 72 006
E.: export@isopipe.gr



SPAIN

Barcelona:

C/ Costa i Deu 71 - 79
(esq. C/ Tamarit)
08205, Sabadell,
Barcelona, Spain

Madrid:

Calle Pedro Duque, 5,
Polígono Industrial GITESA,
28.814- Daganzo de
Arriba (Madrid), Madrid
Community, Spain

T.: +34 93 879 1195
F.: +34 93 879 1313
E.: pedidos@isopipe.es



UNITED KINGDOM

Head Office:

178 Seven Sisters Road
London N7 7PX
United Kingdom

Warehouse:

Airfield Industrial Estate Warboys,
Huntingdon
Cambridgeshire PE28 2SH
United Kingdom

Tel: +44 (0) 208 299 9545
E: orders@isopipe.eu